

LEAD-FREE  
& ROHS

# SPECIFICATION FOR APPROVAL

[www.jengshi.com](http://www.jengshi.com)

**JENG SHI ELECTRONICS CO., LTD**

**正 旭 電 子 有 限 公 司**



DATE: \_\_\_\_\_

CUSTOMER: \_\_\_\_\_

PART NUMBER: SMNR322520CTL-SERIES

CUSTOMER P.N : \_\_\_\_\_

DESCRIPTION: \_\_\_\_\_

APPLICATION: \_\_\_\_\_

**SIGNATURE OF APPROVAL**

\_\_\_\_\_

TEL: 03-365-3086 FAX:03-365-3186 桃園市八德區廣興一路86號

No. 86, Guangxing1st Rd., Bade Dist., TaoyuanCity 334026, Taiwan (R.O.C.)

ERP No

DATE:

CUSTOMER P/N:

REVISION:

A

ITEM:

SMNR322520CTL-SERIES

SPEC No:

SA-S999-072

## REVISIONS

REV	DATE	DESCRIPTION	DRAWN	CHECKER
A		送样承认.	TanHao	Li Qunying

ERP No

CUSTOMER P/N:

ITEM: **SMNR322520CTL-SERIES**

DATE:

REVISION: **A**

SPEC No: **SA-S999-072**

**EXTERNAL DIMENSIONS UNIT: mm**

**ELECTRICAL SCHEMATIC**

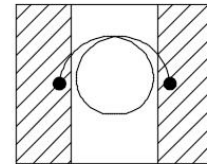
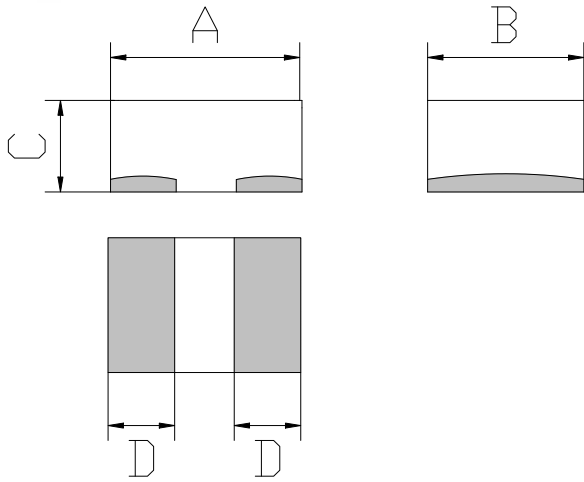

**PAD LAYOUT UNIT: mm**

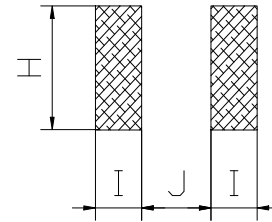

A	B	C	D
3.20±0.3	2.50±0.3	1.80±0.2	1.10±0.3

H	I	J
2.8	0.70	1.5

**NOTE:**

- Operating temperature: -40°C~+125°C
- Storage temperature: -40°C~+125°C
- Storage environment: temperature: 0°C~+40°C humidity: RH10%~70%
- Safe storage life: 12 months

ERP No

DATE:

CUSTOMER P/N:

REVISION:

A

ITEM:

SMNR322520CTL-SERIES

SPEC No:

SA-S999-072

### ELECTRICAL CHARACTERISTICS(@ 25°C)

Part No.	Inductance (uH)	Test Freq (Hz)	DCR (mΩ) (Typ)Max	Isat (A) (Typ)Max	Irms (A) (Typ)Max
SMNR322520CTL-R33M	0.33±20%	100K/1V	(8.00)9.60	(11.0)10.0	(8.50)8.00
SMNR322520CTL-R47M	0.47±20%		(9.30)11.2	(9.00)8.00	(8.00)7.50
SMNR322520CTL-R68M	0.68±20%		(13.3)16.0	(8.00)7.00	(7.00)6.40
SMNR322520CTL-1R0M	1.00±20%		(18.3)22.0	(7.50)6.20	(6.20)5.80
SMNR322520CTL-1R5M	1.50±20%		(25.8)31.0	(6.50)5.00	(5.30)4.80
SMNR322520CTL-2R2M	2.20±20%		(38.0)46.0	(5.00)4.50	(3.70)3.20
SMNR322520CTL-3R3M	3.30±20%		(56.0)65.0	(4.20)3.70	(3.20)2.70
SMNR322520CTL-4R7M	4.70±20%		(90.0)98.0	(3.40)2.90	(2.80)2.40

1.Heat Rated Current (Irms) will cause the coil temperature rise approximately  $\Delta T$  of 40°C

2.Saturation Current (Isat) will cause L0 to drop approximately 30%.

3.The part temperature (ambient + temp rise) should not exceed 125°C under worst case operating conditions.Circuit design,component,PCB trace size and thickness,airflow and other cooling provisions all affect the part temperature. Part temperature should be verified in the end application.

4.Irms Testing : Temperature rise is highly dependent on many factors including pcb land pattern, trace size, and proximity to other components. Therefore temperature rise should be verified in application conditions.

5.Rated DC Current : The less value which is Irms or Isat

6.Rated voltage 25V DC, The application of voltage depends on many factors, Over voltage may cause components failure、high temperature、and burn-out, User needs to verify for appropriate usage.

ERP No

DATE:

CUSTOMER P/N:

REVISION: A

ITEM: SMNR322520CTL-SERIES

SPEC No: SA-S999-072

## Material List

No. Description Specification

- a Core
- b Wire
- c Termination

## Product photos

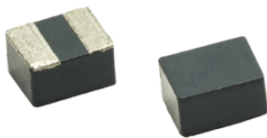

ERP No

DATE:

CUSTOMER P/N:

REVISION: **A**

ITEM: **SMNR322520CTL-SERIES**

SPEC No: **SA-S999-072**

**Curve**

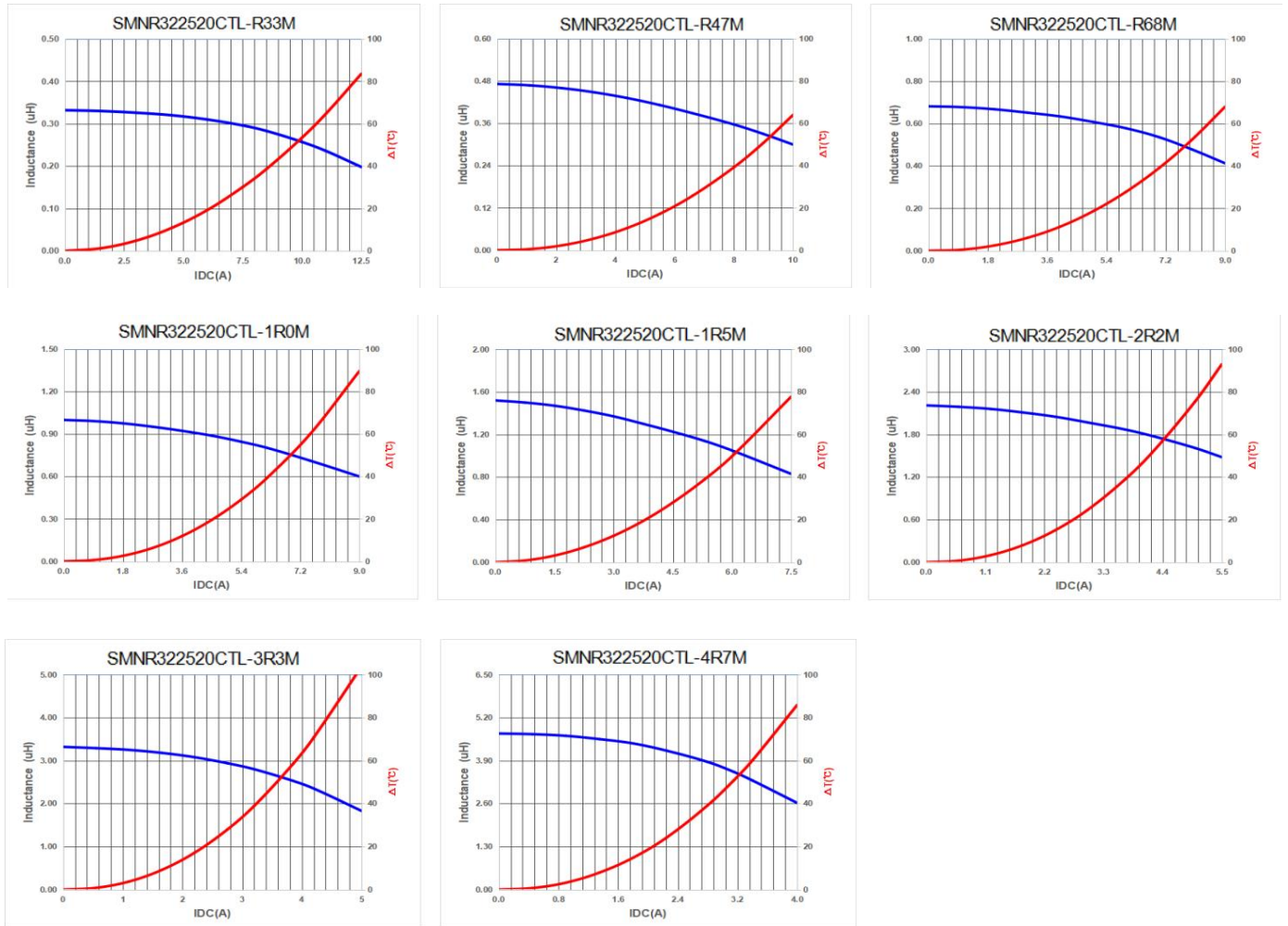

ERP No

CUSTOMER P/N:

ITEM:

**SMNR322520CTL-SERIES**

DATE:

REVISION:

SPEC No:

**A**

**SA-S999-072**

**Packing**

**Carrier Tape (Unit:mm)**

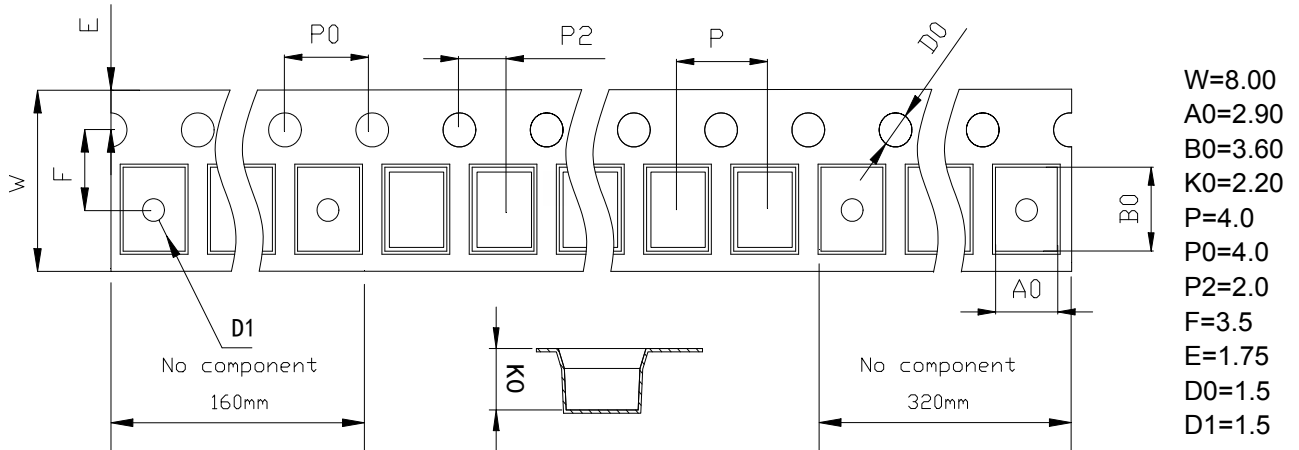

透明載帶+透明上帶

**Reel (Unit:mm)**

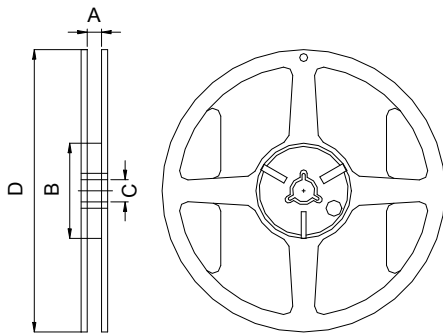

A=8.4  
 B=60  
 C=13.0  
 D=178

**QTY**

Reel(Pcs) 2,000

Middle Carton(Pcs)

Big Carton(Pcs)

N.W(Kg)

G.W(Kg)