

SPECIFICATION FOR APPROVAL

www.jengshi.com

JENG SHI ELECTRONICS CO., LTD

正 旭 電 子 有 限 公 司



DATE: _____

CUSTOMER: _____

PART NUMBER: SMNR322512CTL-SERIES

CUSTOMER P.N : _____

DESCRIPTION: _____

APPLICATION: _____

SIGNATURE OF APPROVAL

ERP No

DATE:

CUSTOMER P/N:

REVISION:

A

ITEM:

SMNR322512CTL-SERIES

SPEC No:

SA-S999-071

REVISIONS

REV	DATE	DESCRIPTION	DRAWN	CHECKER
A		送样承认.	TanHao	Li Qunying

ERP No

DATE:

CUSTOMER P/N:

REVISION:

A

ITEM:

SMNR322512CTL-SERIES

SPEC No:

SA-S999-071

EXTERNAL DIMENSIONS UNIT: mm

ELECTRICAL SCHEMATIC

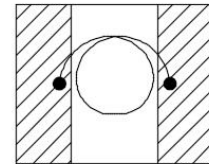
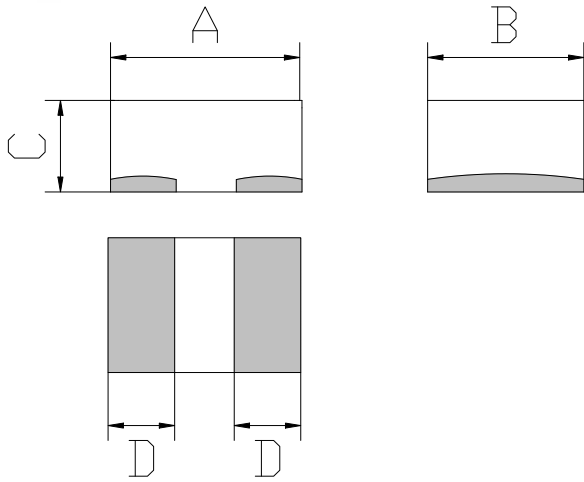

PAD LAYOUT UNIT: mm

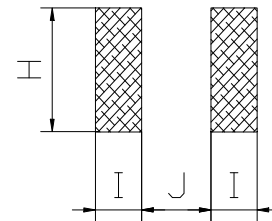

A	B	C	D
3.20 ± 0.3	2.50 ± 0.3	1.00 ± 0.2	1.10 ± 0.3

H	I	J
2.8	0.70	1.5

NOTE:

- Operating temperature: $-40^{\circ}\text{C} \sim +125^{\circ}\text{C}$
- Storage temperature: $-40^{\circ}\text{C} \sim +125^{\circ}\text{C}$
- Storage environment: temperature: $0^{\circ}\text{C} \sim +40^{\circ}\text{C}$ humidity: RH10%~70%
- Safe storage life: 12 months

ERP No

DATE:

CUSTOMER P/N:

REVISION:

A

ITEM:

SMNR322512CTL-SERIES

SPEC No:

SA-S999-071

ELECTRICAL CHARACTERISTICS(@ 25°C)

www.jengshi.com	Inductance	Test Freq	DCR (mΩ)	Isat (A)	Irms (A)	Email:sales@jengshi.com
Part No.	(uH)	(Hz)	(Typ)Max	(Typ)Max	(Typ)Max	
SMNR322512CTL-R22M	0.22±20%	100K/1V	(7.40)8.50	(9.30)8.70	(9.50)9.00	
SMNR322512CTL-R33M	0.33±20%		(10.0)13.0	(9.10)8.50	(8.50)8.00	
SMNR322512CTL-R47M	0.47±20%		(16.0)19.2	(8.20)7.40	(7.00)6.50	
SMNR322512CTL-R68M	0.68±20%		(20.0)24.0	(7.30)6.80	(6.20)5.70	
SMNR322512CTL-1R0M	1.00±20%		(26.0)32.0	(6.50)5.70	(5.50)5.00	
SMNR322512CTL-1R5M	1.50±20%		(44.0)53.0	(5.00)4.50	(4.40)3.90	
SMNR322512CTL-2R2M	2.20±20%		(61.0)73.0	(4.80)4.30	(4.00)3.60	
SMNR322512CTL-3R3M	3.30±20%		(87.0)101	(3.40)3.00	(3.10)2.80	
SMNR322512CTL-4R7M	4.70±20%		(122)146	(2.80)2.40	(2.20)1.90	

1.Heat Rated Current (Irms) will cause the coil temperature rise approximately ΔT of 40°C

2.Saturation Current (Isat) will cause L0 to drop approximately 30%.

3.The part temperature (ambient + temp rise) should not exceed 125°C under worst case operating conditions.Circuit design,component,PCB trace size and thickness,airflow and other cooling provisions all affect the part temperature. Part temperature should be verified in the end application.

4.Irms Testing : Temperature rise is highly dependent on many factors including pcb land pattern, trace size, and proximity to other components. Therefore temperature rise should be verified in application conditions.

5.Rated DC Current : The less value which is Irms or Isat

6.Rated voltage 25V DC, The application of voltage depends on many factors, Over voltage may cause components failure、high temperature、and burn-out, User needs to verify for appropriate usage.

ERP No

DATE:

CUSTOMER P/N:

REVISION: **A**

ITEM: **SMNR322512CTL-SERIES**

SPEC No: **SA-S999-071**

Material List

No. Description Specification

- a Core
- b Wire
- c Termination

Product photos

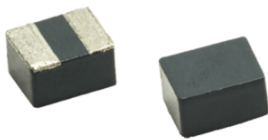

ERP No

DATE:

CUSTOMER P/N:

REVISION: **A**

ITEM: **SMNR322512CTL-SERIES**

SPEC No: **SA-S999-071**

Curve

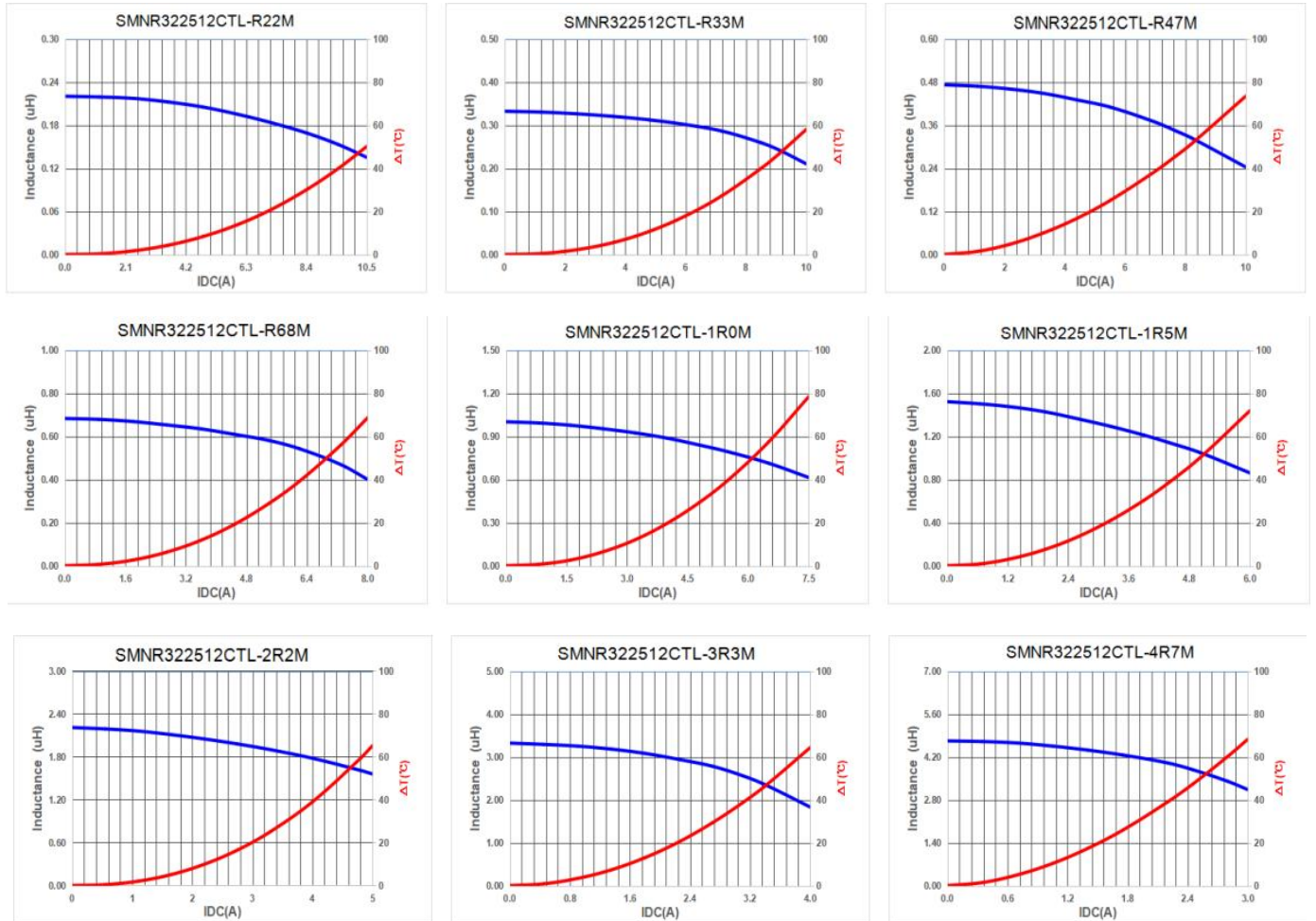

ERP No

DATE:

CUSTOMER P/N:

REVISION:

A

ITEM:

SMNR322512CTL-SERIES

SPEC No:

SA-S999-071

Packing

Carrier Tape (Unit:mm)

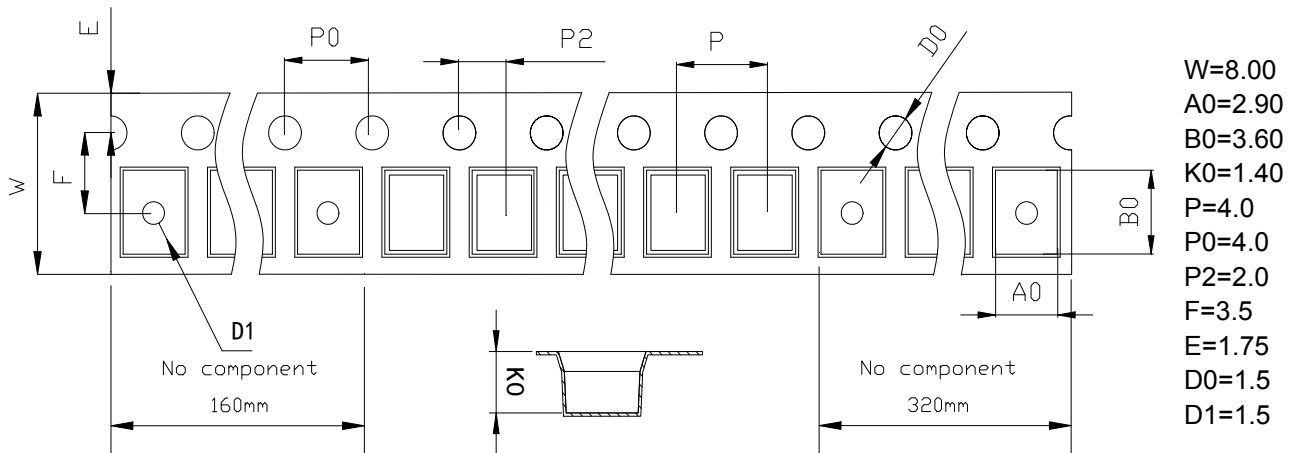

透明载带+透明上带

Reel (Unit:mm)

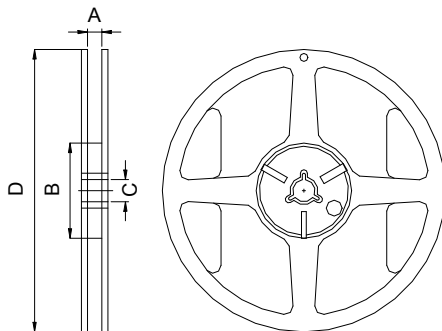

A=8.4
 B=60
 C=13.0
 D=178

QTY

Reel(Pcs) 2,000

Middle Carton(Pcs)

Big Carton(Pcs)

N.W(Kg)

G.W(Kg)